

GPTR-A1xDx

3Gbps PIN-TIA Receiver Modules (Receptacle Module)

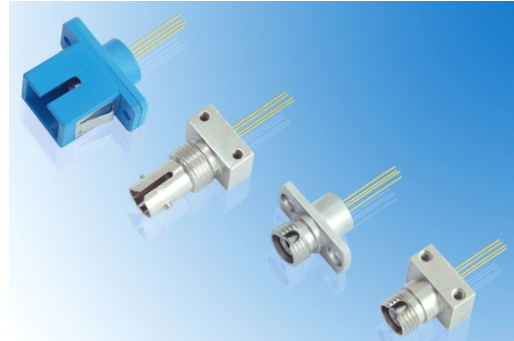

Features

- ◆ High sensitivity
- ◆ Differential ended output
- ◆ Single +3V、+5V、3.3/5V operation
- ◆ Trans-impedance amplifier with AGC
- ◆ RoHS Compliant Products Available

Applications

- ◆ 3Gbps Bit Rate application
- ◆ Fast Ethernet receiver/transceiver application

General

GPTR-A1xCxSeries is a TO-based 3Gbps,5 pin PIN-TIA. It provides high sensitivity with AGC and 100ohm differential outputs.A photodiode is mounted into a low capacitance coaxial package integrated with a receptacle.

Ordering Information (Standard version ^{*Note1})

Part No.	Wavelength (nm)	Voltage (V)	Package	Pin Type	Insulation
GPTR-A13DJ	1100~1650	3.3	A	D	Y
GPTR-A15DB	1100~1650	5	B	D	N
GPTR-A13DE	1100~1650	3.3	E	D	N
GPTR-A15DFJ	1100~1650	5	F	D	Y

*Note1: For more ordering information, please refer the nomenclature and contact EPOTOLINK sales.

Absolute maximum ratings

Parameter	Min	Typ.	Max	Unit
Storage Temperature	-40	25	85	°C
Operating Temperature	-40	25	85	°C
TIA Supply Voltage	2.9	3.3	3.6	V
PD Reverse Voltage	-		15	V
Operation Relative Humidity	-		85	%
Soldering Temperature / Time	-		260/10	°C/s

Electrical and optical characteristics

Parameter	Symbol	Min.	Typ.	Max.	Unit	Test Condition
Operating Wavelength	λ	1100		1650	nm	
Supply Current	I _{cc}			40	mA	No Loads
Saturation Power	P _{sat}	-3	0	-	dBm	VR=5V,25°C
Small-Signal Bandwidth	BW	1.8	2		GHz	at -3dBm
Sensitivity			-21	-19	dBm	$\lambda=1310\text{nm}, 3.125\text{Gbps}, \text{BER}=10^{-10} @ \text{PRBS}=2^{23}-1$
Output Resistance	R _o		50		Ω	
Rise /FallTime	T			4.5		10~90%

Pin Assignment ^{Note2}

TYPE: D

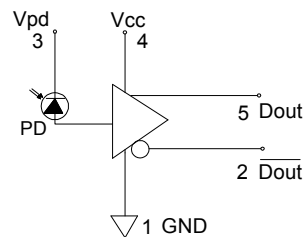
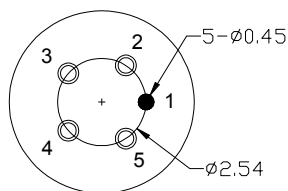

PIN-TIA-pin-D

Note2: Other Pin type can be customized.

Receptacle Package series

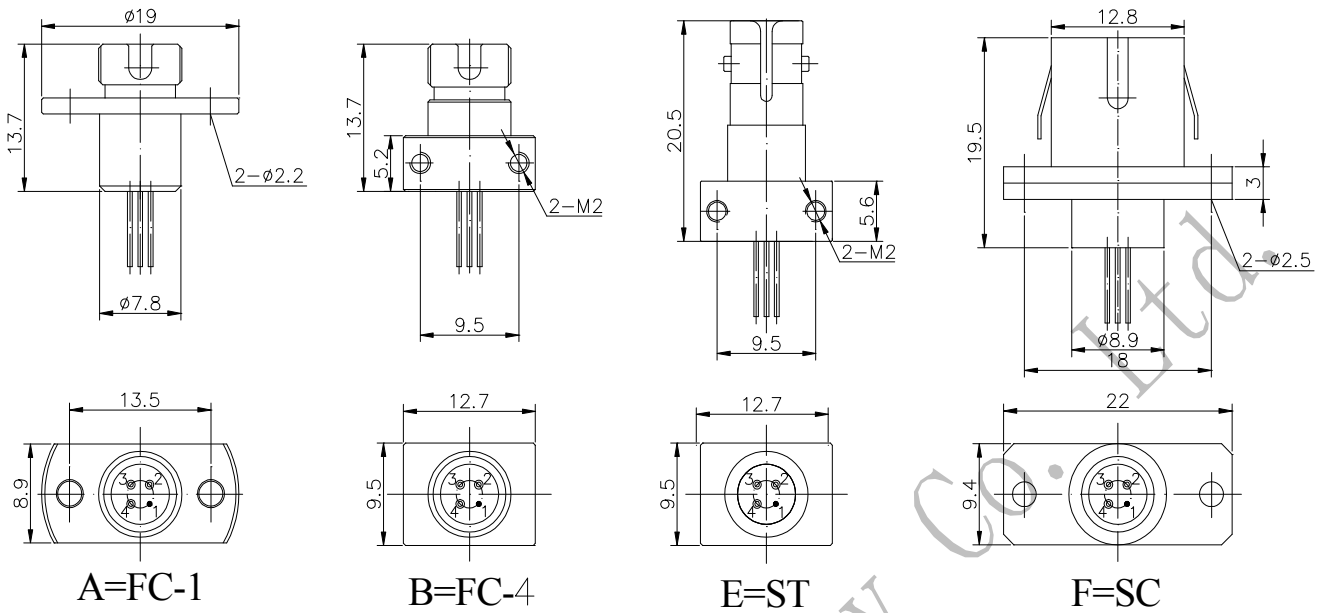

The direction of fix card

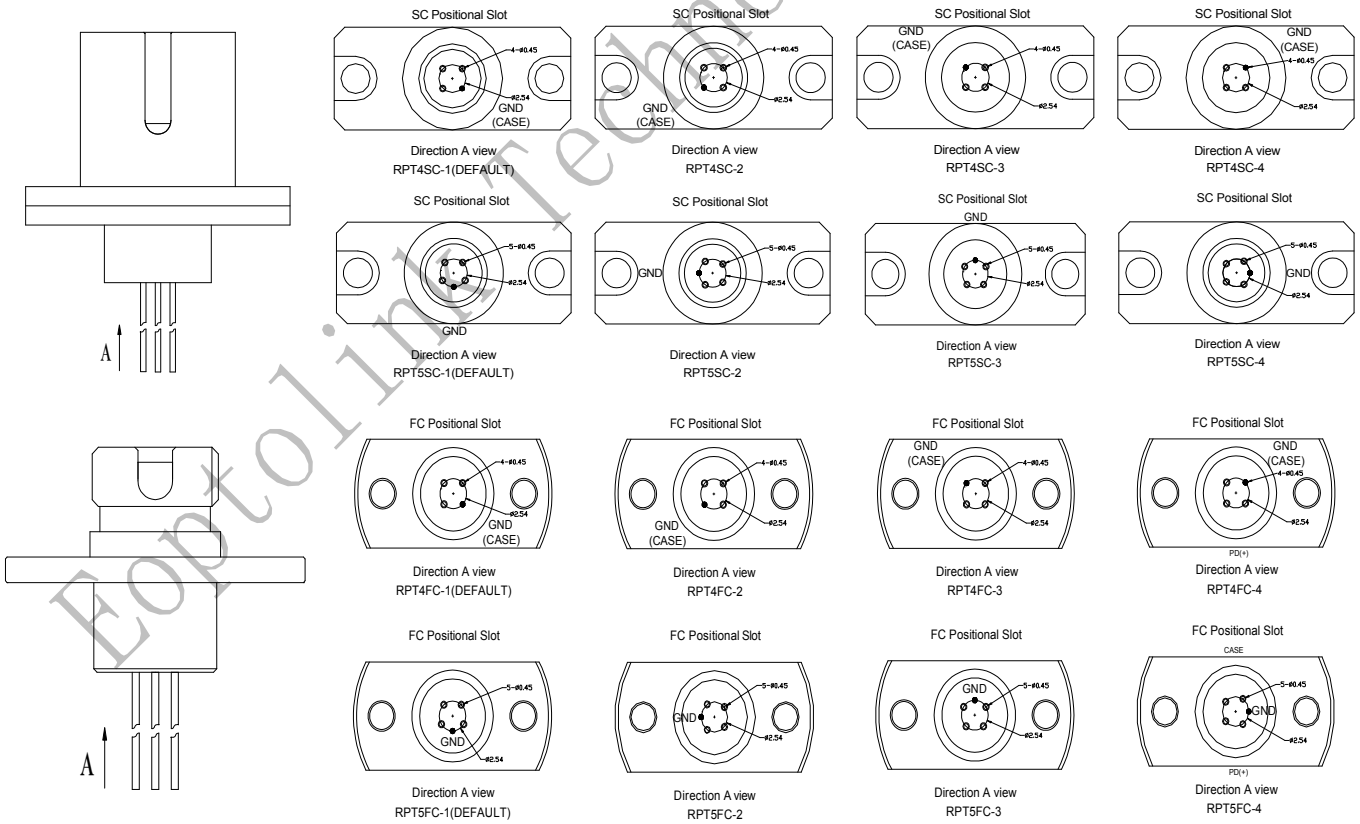

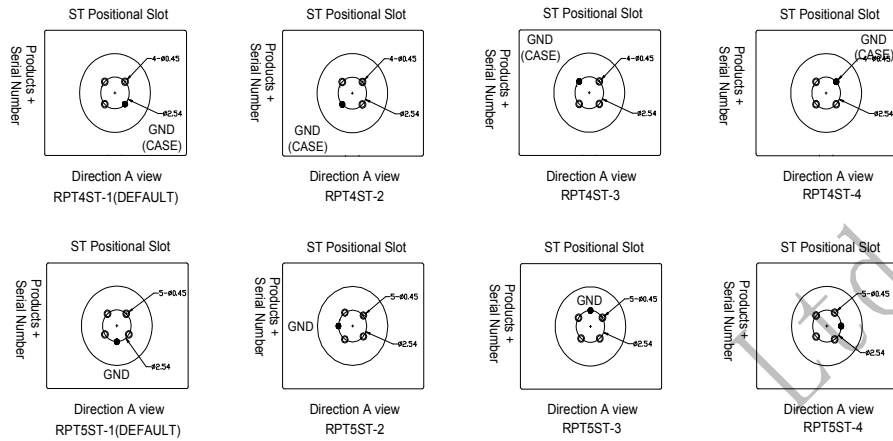
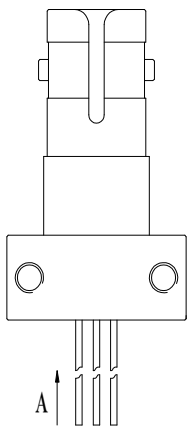

Nomenclature of assembly direction *Note3

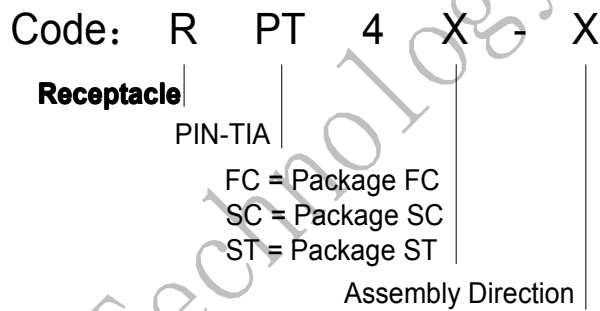

*Note3: Please designate the code of assembly direction.

Nomenclature



A	Date rate	A=3Gbps		
B	Wavelength	1=1100~1650nm		
C	Voltage	3=3.3V	5=5V	0=3.3/5V
D	Pin Type	D= pin-D		
E	Package series	A=FC-1	B=FC-4	E=ST F=SC
F	Insulation	Blank=NO Insulation		J= Insulation

Precaution

- (1) The modules should be handled in the same manner as ordinary semiconductor devices to prevent the electro-static damages. For safe keeping and carrying, the modules should be packaged with ESD proof material. To assemble the modules on PCB, the workbench, the soldering iron and the human body should be grounded.
- (2) Please pay special attention to the atmosphere condition because the dew on the module may cause some electrical damages.
- (3) Under such a strong vibration environment as in automobile, the performance and reliability are not guaranteed.

Obtaining Document

You can visit our website:

<http://www.eoptolink.com>

Or contact Eoptolink Technology Inc., Ltd. listed at the end of the documentation to get the latest documentation.

Revision History

Verision	Initiated	Reviewed	Approved	Release Date
Vb-1	jack.jiang	Zore.Zhao Kelly.Cao		2011-9-7

Notice:

Eoptolink reserves the right to make changes or discontinue any product or service identified in this publication, without notice, in order to improve design and/or performance. Applications that are described herein for any of the products are for illustrative purposes only. Eoptolink makes no representation or warranty that such applications will be suitable for the specified use without further testing or modification.

Contact:

Add: Floor 5, Building 2, No. 21 Gaopeng Avenue, High-Tech District, CHENGDU, SICHUAN 610041 P.R. CHINA

Tel: (+86) 028-85122709 ext 816 & 809

Fax: (+86) 028-85121912

Postal: 610041

E-mail:sales@eoptolink.com

<http://www.eoptolink.com>